



Volkswagen

The Caddy Life



Contents

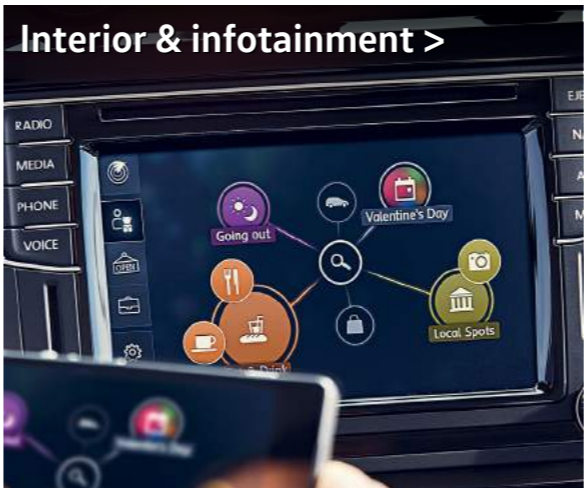
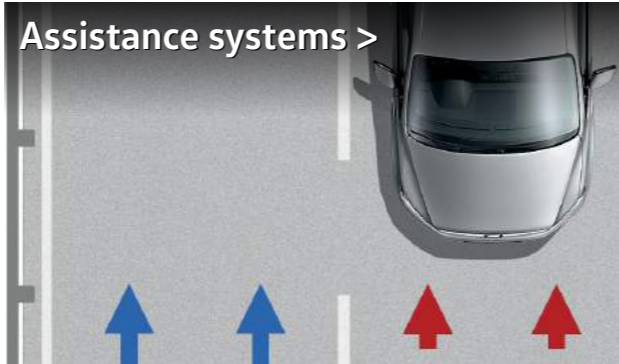

Designed for everyday life.

No matter how you look at it, the Caddy Life impresses from every angle. Designed for life, its uncluttered contours and dynamic styling deliver a bold stance. Clever design details such as the tailgate's integrated roof spoiler, elegantly sculptured rear light clusters, stylish side indicators and an attractive range of alloy wheels help it to stand out – whether it's a family holiday or the regular school run.



Optional Bi-xenon headlights.



Standard stylish rear light clusters.



Standard side sliding doors with sliding windows and child locks. Optional privacy glass is also available.



Stylish 17" Canyon alloy wheels. Optional on Caddy Maxi Life models.

The interior.

Step inside the Caddy Life and you'll find a quality interior that's attractive, ergonomic and rugged. Seating up to seven (including the driver), you'll feel totally at home in a driver's seat with 8-way adjustment, including height and lumbar support and a leather steering wheel that adjusts for reach and rake. Of course, safety is of paramount importance, so the driver and front passenger receive front and curtain airbags, height-adjustable headrests, 3-point seatbelts that adjust for height and seatbelt tensioners as standard. At the rear there's seating for up to five further passengers along two rows of seats. These also feature curtain airbags, 3-point seatbelts and height-adjustable headrests as standard. For the protection of younger passengers, ISOFIX child seat mountings are fitted to the two outer seats on the three-seat bench in the second row. In a vehicle where flexibility is key, you'll find the rear passenger area includes a host of storage solutions and supportive, flexible seating that can be configured in a variety of positions, or completely removed to create a cavernous load area that's able to cope with most of what life can throw at it.



Optional Composition Media DAB+ radio system.



Standard leather multi-functional steering wheel.



Optional App-Connect system.

Infotainment systems.

When you get behind the wheel of the Caddy Life, you'll be greeted by an ergonomic, highly-specified interior with quality finishing and an exclusive atmosphere. With the current generation Caddy Life, we've taken things a step further by offering a range of stylish and innovative radio and infotainment systems.

Radio and navigation. Devices include the standard Composition Colour touch-screen DAB+ radio system and optional Composition Media DAB+ radio system.

App-Connect. Available as an option, App-Connect allows you to operate special apps. The screen of your smartphone can be shown on the radio system's display.

Connectivity. Available as an option, external media devices, such as MP3 players, can be connected via an additional USB port. Furthermore, the standard mobile phone interface offers a Bluetooth® hands-free speaking system.

Volkswagen Media Control. Available as an option, your smartphone or tablet is turned into a remote control and is able to operate the audio system functions from the rear seats via a Wi-Fi connection.

The flexible passenger compartment.

When you need to transport passengers and their luggage, we know that flexibility is key. With this in-mind, we've designed the Caddy Life's passenger compartment to offer versatility in abundance with seats that can be folded, double-folded or completely removed. What's more, with the optional load-through facility, the interior load length increases to an impressive 3.1m. When you also consider the low rear sill height and flat load surface, you'll discover a passenger compartment that's as spacious as it is flexible.

Caddy Life.
Standard 5 seats.



5 Seats

Caddy Maxi Life.
Standard 7 seats.



7 Seats

The **Caddy Maxi Life** is **470mm** longer than the Caddy Life and offers an additional **340 litres** of luggage space.



Second row bench folded down.



Second row bench folded forward.



Second row bench removed.

Safety systems.

Your safety is vital, so we ensure that a long list of safety and security features are built into every vehicle we produce. Since we first introduced structural safety features on commercial vehicles over 35 years ago, Volkswagen has maintained a policy of continuous safety development. Every Volkswagen model incorporates a range of both active and passive safety features, to help ensure the safety and security of both you, your passengers and your load.

With the vehicle's design contributing to safety, occupants are securely enclosed within a rigid safety cell with crumple zones to absorb crash energy, while the chassis and suspension are designed for excellent directional stability and handling. Features such as Anti-lock Braking System (ABS), Electronic Brakeforce Distribution (EBD), Electronic Stabilisation Programme (ESP), driver and passenger front and curtain airbags, electric seatbelt tensioners, Automatic Post-Collision Braking System and ISOFIX child seat mountings to the outer seats in the rear passenger area are fitted as standard.

For additional security and protection, an electronic immobiliser and remote central locking with dead locking and internal locking button are standard, while optional features such as anti-theft devices, front and rear parking sensors, Bi-xenon headlights, automatic rain-sensing wipers and front fog lights with integrated cornering lights all offer additional peace-of-mind.



Automatic Post-Collision Braking System.
Standard on all Caddy Life and Caddy Maxi Life models, it triggers braking after a collision, with the aim of preventing secondary collisions.



Electronic Stabilisation Programme (ESP).
Designed to prevent the vehicle from swerving in critical driving conditions by controlled and targeted intervention in the brake and engine management. This helps to maximise directional stability.



Anti-lock Braking System (ABS).
Designed to prevent wheels from locking up and assist manoeuvrability of the vehicle under heavy braking.

Traction Control System (TCS).
Aids smooth starts and acceleration by reducing wheel-spin. The system also incorporates the Electronic Differential Lock (EDL) and makes up part of the Electronic Stabilisation Programme (ESP).



Electronic Differential Lock (EDL).
Allows smooth starts on slippery or loose road surfaces. If one wheel starts to spin, EDL is designed to brake the wheel as necessary, directing power to the wheel with greater traction.



Airbags.
Driver and passenger front and curtain airbags are standard for the first time, as are curtain airbags for rear passengers. They offer occupants improved protection in the event of head-on or side impacts..



Seatbelt warning.
The seatbelt warning reminds the driver that their seatbelt is not fastened. Audio and visual signals are used to request that the seatbelt is fastened before driving.

[Watch video >](#)



Automatic Post-Collision Braking System.
Standard on all Transporter models, it triggers braking after a collision, with the aim of preventing secondary collisions.

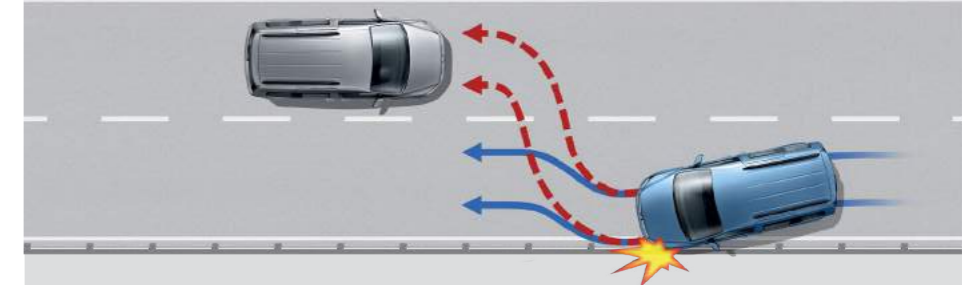

Driver assistance systems.







To help ensure every journey ends as stress-free as it begins, the Caddy Life and Caddy Maxi Life are equipped with a number of intelligent systems – all of which are activated in critical situations as a preventative measure. Add to this a variety of innovative driver assistance systems and you'll discover the Caddy Life and Caddy Maxi Life offer high levels of safety and peace-of-mind.



Optional parking sensor display.



Optional rear-view camera display.

 <p>Cruise control including speed limiter. Fitted as standard, cruise control maintains the selected speed, or limits the top speed to a value set by the driver.</p>	 <p>Brake Assist. Fitted as standard, the system registers the speed at which the brake pedal is pressed. During emergency braking, it helps ensure full brake pressure is applied more quickly.</p>	 <p>Hill Hold Assist. Fitted as standard, the convenient Hill Hold Assist helps to prevent your vehicle from rolling back when pulling away on an incline. The hold operates for approximately two seconds.</p>
 <p>Driver Alert System. Fitted as standard, the Driver Alert System registers deviation from normal steering patterns and uses visual and acoustic warnings to recommend that the driver takes a break.</p>	 <p>Daytime running lights. Fitted as standard, daytime running lights offer increased visibility. For extra driver convenience, the dipped beam headlights are automatically switched on when you start your vehicle.</p>	 <p>Tyre pressure monitoring. Fitted as standard, the tyre pressure monitoring display activates a warning signal to highlight significant changes in tyre pressure. This lets the driver know that the tyre pressure should be checked as soon as possible.</p>

An intelligent driving experience. Assistance when you need it.

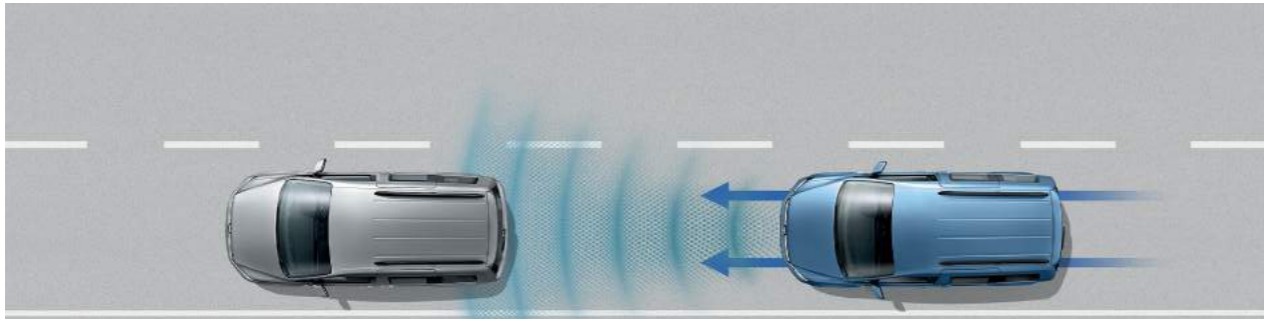

Front Assist with City Emergency Braking System.

Standard Front Assist area monitoring system with City Emergency Braking System detects critical distances, warns of hazardous situations and when necessary, triggers emergency braking.



Adaptive Cruise Control (ACC).

Available as an option, ACC uses a front radar to measure the distance (up to 120m) and speed relative to vehicles driving ahead. It automatically regulates the pre-set distance.

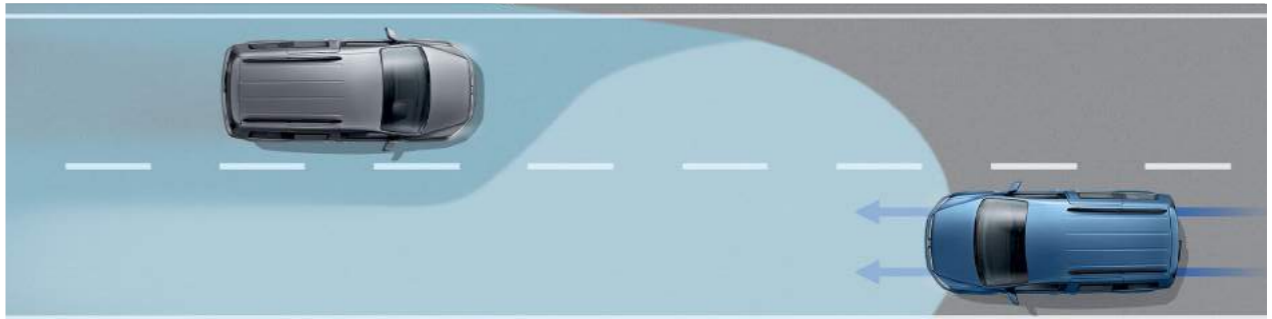

High Beam Assist.

Available as an option, High Beam Assist automatically dips the headlights and prevents dazzle for oncoming vehicles, or vehicles travelling ahead. At night time at speeds of above 37mph, the system automatically switches the headlights to high-beam.

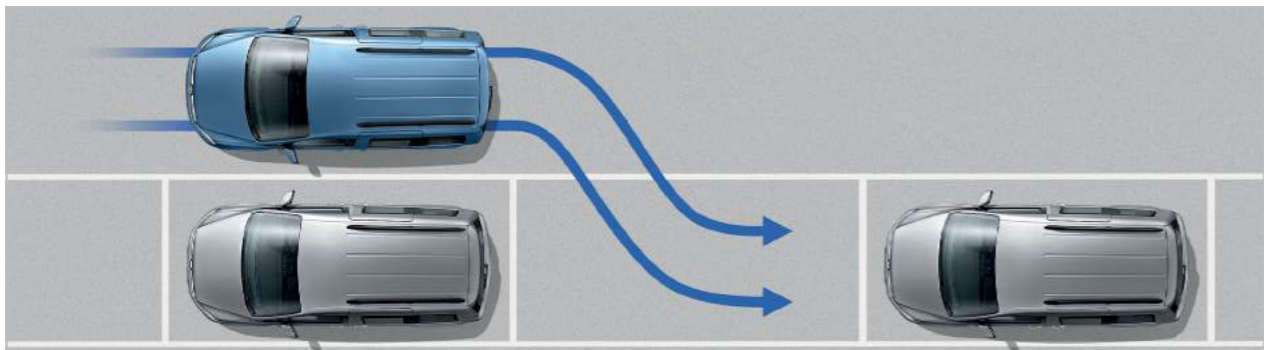

Park Assist.

This useful option aids positioning into parking spaces. When reverse is engaged, the vehicle assumes control of the steering. All that's required of the driver is to operate the clutch, accelerator and brake pedals.

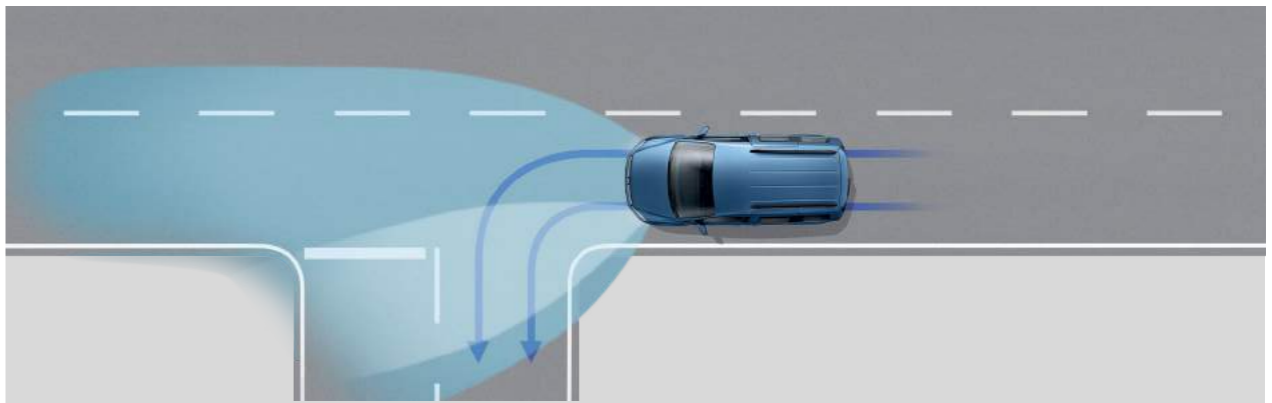

Fog lights with integrated cornering lights.

Available as an option, these help to illuminate curves and bends in the road ahead. This aids the driver in spotting any obstacles where the vehicle is turning.

The Caddy Life.

When you need a vehicle with the ability to adapt to your way of life, be it private or commercial use, the Caddy Life has the answer. Seating up to five (including the driver) as standard, it's as equally at home whether packed with passengers, or with the seats removed, loaded with bikes, luggage, camping gear and other bulky items that wouldn't easily fit into a conventional passenger vehicle. Access is through near-side and off-side sliding doors and a standard tailgate with heated window and wash-wipe. If preferred, glazed asymmetric rear wing doors can be specified as an option. With a comprehensive standard specification including, full wheel trims and sumptuous Kutamo cloth upholstery, the Caddy Life is ideal for users who desire more.

Starting from **£21,978** [Please click here for more details.](#)



Climatic air conditioning for cab and rear passenger area.



Standard open storage tray with 12V socket.



Standard above-cab storage shelf.

The Caddy Maxi Life.

Starting from **£24,774** [Please click here for more details.](#)

The Caddy Maxi Life features a near identical specification to the shorter Caddy Life, with the addition of the most valuable of commodities – more space. Seating up to seven as standard (including the driver), it's 470mm longer and offers an impressive extra 340 litres of load capacity. For passengers, this means more space to relax, but most importantly, extra space for luggage or kit. What's more, for the perfect finishing touches, 16 or 17 inch stylish alloy wheels contribute to the road presence of the Caddy Maxi Life. Offering a blend of comfort, flexibility and space, it's the perfect family vehicle.



Caddy Life and Caddy Maxi Life standard equipment.

Audio and communications.

Composition Colour DAB+ radio including AUX-IN, SD card slot, Bluetooth®, MP3 compatible CD player and six speakers.

Wheels and tyres.

15" or 16" full wheel trims (Caddy Life).

16" Fortaleza alloy wheels (Caddy Maxi Life).

Full size steel spare wheel.

Tool kit and jack.

Efficiency technology.

Hill Hold Assist.

Low rolling resistance tyres.

Regenerative braking.

Start/Stop.

Exterior.

Black protective side strips.

Body-coloured door mirrors and handles.

Body-coloured front and rear bumpers.

Fixed side windows in third row.

Front fog lights.

Heated windscreen.

Radiator grille with single chrome finishing strip.

Roof rails finished in Black.

Side sliding doors to passenger compartment on driver and passenger side.

Sliding windows and child locks within both side sliding doors to passenger compartment.

Tailgate with heated window and wash-wipe.

60 litre fuel tank.



15" full wheel trims. Standard on Caddy Life 102PS.



Radiator grille with single chrome finishing strips.



16" Fortaleza alloy wheels. Standard on Caddy Maxi Life.



Front fog lights. Also available with optional cornering lights.



Composition Colour DAB+ radio system.

Caddy Life and Caddy Maxi Life standard equipment (continued).

Interior – cab area.

- Carpet floor covering.
- Centre armrest between driver and front passenger seats.
- Climatic manually controlled air conditioning with dust and pollen filter and air recirculation.
- Digital clock.
- Dimmable dashboard illumination.
- Door mirrors – electrically heated and adjustable.
- Driver seat with 8-way adjustment, including height and lumbar support.
- Electric front windows.
- Four drinks holders and storage compartment in centre console.
- Interior light in headliner.
- Kutamo cloth upholstery.
- Leather multi-function steering wheel, gearknob and gaiter.
- Lockable glovebox with illumination.
- Passenger seat with 8-way adjustment, including lumbar support.
- Reach and rake adjustable steering column.
- Rear-view mirror with anti-dazzle function.
- Servotronic speed-related power-assisted steering.
- Trip computer with multi-function display.
- Twin sun visors with vanity mirrors.
- Under-seat storage compartment below driver and front passenger seats.
- 12V sockets x 3 – dashboard front, dashboard top tray and luggage compartment.

Interior – passenger area.

- Carpet floor covering.
- Five seats, including the driver (Caddy Life).
- Folding luggage compartment cover.
- Four overhead nets.
- Kutamo cloth upholstery.
- Seven seats, including the driver (Caddy Maxi Life).
- Six load-lashing rings.
- Three-seat bench in second row – split/folding and removable with ISOFIX mountings to outer seats.
- Two door-activated interior lights.
- Two-seat bench in third row – removable (Caddy Maxi Life).



Load-lashing rings.



Climatic air conditioning for cab and rear passenger area.

Safety and security.

- Airbags – driver and front passenger (with passenger deactivation), front side and curtain head protection to front and second row.
- Anti-lock Braking System (ABS).
- Automatic hazard light activation under emergency braking.
- Cruise control with speed limiter.
- Electronic Brakeforce Distribution (EBD).
- Electronic Differential lock (EDL).
- Electric seatbelt tensioners.
- Electronic Stabilisation Programme (ESP).
- Engine drag torque control (MSR).
- Front Assist with City Emergency Braking System.
- Halogen main headlights with range control and daytime running lights.
- Height-adjustable head restraints.
- Remote central locking with deadlocks, interior locking and two remote keys.
- Seatbelt warning when not engaged.
- Thatcham category 1 approved alarm and immobiliser.
- Traction Control System (TCS).
- Visibility pack including auto-dimming rear-view mirror, rain sensors with automatic wipers and intermittent control.



Electric front windows.

Paint and upholstery.

Formulated to withstand the rigours of everyday life, the Caddy Life's paint and upholstery are designed to stand the test of time. As you'd expect from any Volkswagen, exterior paints offer a smooth and tough finish, while the interior upholstery is made from high-quality materials that are both attractive and robust.



Candy White solid paint



Cherry Red solid paint



Reflex Silver metallic paint.¹



Indium Grey metallic paint.¹



Sandstorm Yellow metallic paint.¹



Fortana Red metallic paint.¹



Blackberry metallic paint.¹



Chestnut Brown metallic paint.¹



Viper Green metallic paint.¹



Bamboo Garden Green metallic paint.¹



Starlight Blue metallic paint.¹



Acapulco Blue metallic paint.¹



Deep Black pearl effect paint.¹

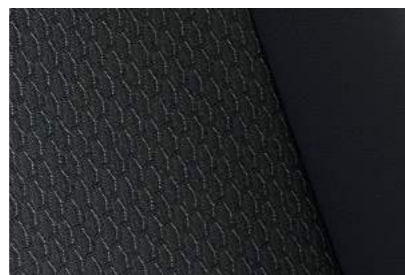

Kutamo L ML
Titanium Black/Moonrock Grey cloth

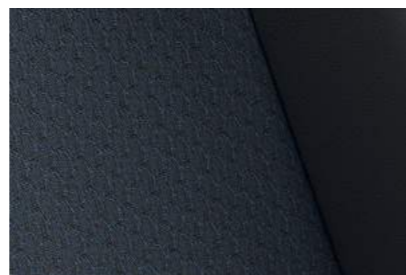

Kutamo L ML
Titanium Black/Blue cloth

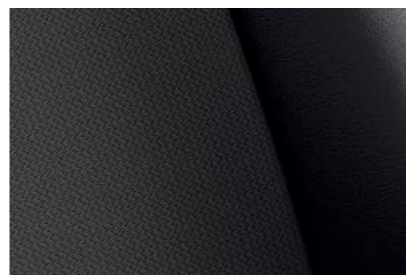

Mesh¹ L ML
Titanium Black synthetic leather

¹ Available at extra cost.

Please note: Not all paint and upholstery combinations can be ordered together and in some instances certain combinations may incur extra cost. Not all paint finishes may be available for every trimline. Please check details and availability with your Volkswagen Van Centre at the time of ordering. Screen representations do not allow exact reproduction of paint and upholstery colours.

Standard Optional
L | Caddy Life ML | Caddy Maxi Life

Wheels.

01 15" full wheel trim. Standard on Caddy Life 102PS.

02 15" Caloundra. 6J x 15 alloy wheels with 195/65 R15 tyres.

03 16" Bendigo. 6J x 16 alloy wheels with 205/55 R16 tyres.

04 16" Fortaleza. 6J x 16 alloy wheels with 205/55 R16 tyres. Standard on Caddy Maxi Life.

05 17" Canyon. Silver/Anthracite. 6J x 17 alloy wheels with 205/55 R17 tyres.



Audio and communications.



01



02

01 Composition Colour DAB+ radio system.
Standard on all Caddy Life models, the Composition Colour DAB+ radio system features a 5" TFT touch-screen colour display, USB port, Bluetooth®, SD card slot, AUX-IN interface, MP3 and WMA compatible CD drive, 4 x 20 watt output with six speakers and a dual tuner with PhaseDiversity for optimum radio reception.

02 Composition Media DAB+ radio system.
The optional Composition Media DAB+ radio system features an increased touch-screen size of 6.33" with proximity sensor, USB port, Bluetooth®, SD card slot, AUX-IN interface, MP3 and WMA compatible CD drive, 4 x 20 watt output with six speakers and a dual tuner with PhaseDiversity for optimum radio reception. App-Connect is available as an option for this system.



03



04

03 Discover Media satellite navigation system.
The optional Discover Media satellite navigation system builds on the strengths of the Composition Media DAB+ radio system by adding satellite navigation and a second integrated SD card slot compatible for map data. The system includes free updates for the pre-installed European maps through Volkswagen MapCare. App-Connect is available as an option for this system.

04 App-Connect.¹ Available as an option with the Composition Media DAB+ radio system or Discover Media navigation system. App-Connect allows you to operate special apps. The screen of your smartphone can be shown on the radio system's display.

¹ The 'App' control button on the optional Discover Media navigation system is only enabled when ordered in conjunction with the optional App-Connect system.

Mobile online services.

Optional App-Connect – Volkswagen apps.¹

Download special Volkswagen apps to your mobile or tablet, such as 'Shared Audio', 'Drive & Track', 'Call & Remind', 'My Guide' and 'Sound Journey' to make every journey more pleasant and interesting. The apps provide you with information about your driving behaviour, guide you to parking spaces in the vicinity, make detailed suggestions about exciting destinations – all taking into account the weather and traffic data.

Optional Car-Net Guide & Inform.²

Use Car-Net Guide & Inform to enhance your vehicle's optional Discover Media navigation system with online-based, up-to-date information services for greater convenience when travelling. For example, utilise real-time traffic information to avoid a sudden traffic jam, or refuel at the cheapest fuel station, or find a free parking space without the need for an infuriating search. Car-Net Guide & Inform helps you to reach your destination quickly and with the least amount of stress.

 **Online traffic information.**
Save time and avoid stress with real-time traffic information, enabling you to avoid traffic jams by dynamically adapting your route.

 **News.**
Subscribe to personalised news categories and use the news feeds to stay up-to-date.

 **Fuel stations.³**
View the fuel stations with the cheapest fuel prices in your immediate vicinity. Your vehicle's fuel type is automatically identified.

 **Online destination import.**
Conveniently plan your driving destinations from home using the customer portal and retrieve them using the navigation system.

 **Parking spaces.³**
Save time and view available parking options, along with prices and opening hours.

 **My special destinations.**
Use the customer portal to save your preferred destinations while at home and import these into your vehicle's navigation system.

 **Weather.**
Stay up-to-date with the latest weather information while on the move.

 **Vehicle status report.**
Retrieve the latest service information and error messages from your vehicle.

 **Online special destination search.**
Customised information about local services is sent directly to your touch-screen display.

 **Car-Net registration in a few easy steps:**

1. Create your personal account on the Car-Net website.
2. You will receive a registration code (PIN).
3. Enter your vehicle identification number (VIN).
4. Enter the PIN into your vehicle's navigation system.

1 Available as an option, App-Connect is only available in conjunction with the Composition Media DAB+ radio system or the Discover Media satellite navigation system. App-Connect comprises MirrorLink™, CarPlay™ and Android Auto™. The availability of these technologies can vary depending on the country in question. Please note that App-Connect is not currently supported by all mobile telephones on the market. Volkswagen is working closely with major smartphone producers to promote broader compatibility for App-Connect.

2 Available as an option, mobile online services (Car-Net) is only available in conjunction with the Discover Media satellite navigation system. You will also require a mobile device that is capable of acting as a mobile wireless hotspot. Car-Net services are only available with an existing mobile network contract or one to be agreed separately for this purpose between you and your mobile phone network provider and only within the respective mobile phone network coverage. Depending on your mobile phone tariff, receiving data from the internet may incur additional charges, particularly if you are using the phone abroad. Due to the amount of data needed when using Car-Net services, we strongly recommend signing-up to a data flat rate with your mobile phone provider. Use of Car-Net is governed in a separate agreement with Volkswagen AG online. After taking possession of the vehicle, you have 90 days in which to register the vehicle at www.volkswagen-commercial-vehicles-carnet.com. The availability of Car-Net services may vary depending on the country in question. These services are available for the duration of the contract term agreed and may be subject to changes in terms of content during the contract period. More detailed information on Car-Net is available at www.volkswagen-commercial-vehicles-carnet.com and from your Volkswagen Commercial Vehicles Van Centre. Contact your mobile network provider for information regarding your mobile network tariff.

3 Available at participating fuel stations and car parks.

Engine and gearbox data.

Engine specifications.	2.0TDI 102PS
Engine type	Diesel, transverse, water-cooled, in-line, variable turbine geometry turbocharger with intercooler
Mixture preparation/injection method	Common-rail, direct injection
EU exhaust emission standard	EU6D Temp
Number of cylinders	4
Cubic capacity	1,968cc
Output, PS at rpm	102 at 2,900-4,000
Torque, max. Nm at rpm	250 at 1,300-2,800
Fuel tank capacity	60 litre
AdBlue® capacity	9 litre
Diesel Particulate Filter [DPF]	●
5-speed manual gearbox	●
6-speed manual gearbox	-
6-speed dual clutch gearbox [DSG]	○
Front-wheel drive	●
Alternator	110A
Battery	61Ah (330A)

● Standard ○ Available - Not available

Fuel consumption, performance and emissions.

Engine/transmission	CO ₂ emissions, g/km ¹		Combined fuel consumption mpg ¹		Combined fuel consumption (ltr/100km) ¹		Acceleration, seconds 0 - 62mph	Top speed, mph, (where law permits)
	Max.	Min.	Max.	Min.	Max.	Min.		
Caddy Life.								
2.0TDI 102PS 5-speed manual	131	131	48.7	51.4	5.8	5.5	12.9	107
2.0TDI 102PS 6-speed DSG	142	142	44.8	47.9	6.3	5.9	13.0	106
Caddy Maxi Life.								
2.0TDI 102PS 5-speed manual	134	134	47.9	50.4	5.9	5.6	13.3	107
2.0TDI 102PS 6-speed DSG	142	142	44.1	46.3	6.4	6.1	13.4	106

¹ This brochure relates to vehicles tested according to WLTP technical procedures. Figures shown are for comparability purposes; only compare fuel consumption and CO₂ figures with other vehicles tested to the same technical procedures. These figures may not reflect real life driving results, which will depend upon a number of factors including the accessories fitted (post-registration), variations in weather, driving styles and vehicle load. There is a new test used for fuel consumption and CO₂ figures (known as WLTP). The CO₂ figures shown however, are based on a calculation designed to be equivalent to the outgoing (NEDC) test cycle and will be used to calculate vehicle tax on first registration. For more information please visit <https://www.volkswagen-vans.co.uk/en/about-us/wltp.html> or consult your authorised Volkswagen Van Centre.

Data correct at 11.12.2018. Figures quoted are for a range of configurations (including non-UK) and are subject to change due to ongoing approvals/changes.

Weights.

Engine/transmission	Gross vehicle weight, kg	Axle load limit, front/rear, kg	Trailer weight braked 12%/unbraked, kg	Gross train weight, kg	Unladen weight ¹ , kg	Payload ² , kg
Caddy Life.						
2.0TDI 102PS 5-speed manual	2,275	1,150 / 1,200	1,500 / 730	3,700	1,618	657
2.0TDI 102PS 6-speed DSG	2,280	1,170 / 1,200	1,500 / 750	3,780	1,654	626
Caddy Maxi Life.						
2.0TDI 102PS 5-speed manual	2,350	1,175 / 1,250	1,350 / 750	3,650	1,742	608
2.0TDI 102PS 6-speed DSG	2,380	1,200 / 1,250	1,400 / 750	3,780	1,778	602

1 Unladen weight includes approximately 90% fuel load and 75kg for driver.

2 Payload = gross vehicle weight minus unladen weight. Quoted weights are for vehicles with standard specification. Unladen weight and payload may be influenced by trimline, factory options and Van Centre fitted accessories. Roof load limit: 100kg. Trailer nose weight: 80kg.

Dimensions.

Caddy Life.

Wheelbase		2,682
Load compartment	length	1,353
	width	1,161
	width between wheel arches	1,136
	height	1,226
	load volume (seats in place)	2 seats: 3,200 litres 5 seats: 918 litres 7 seats: 190 litres
load length (seats in place)	2 seats:	1,781
	5 seats:	1,095
	7 seats:	224
Side sliding door	width	701
	height	1,084
Tailgate	width	1,183
	height	1,127
Turning circle (wall to wall)		11.1m

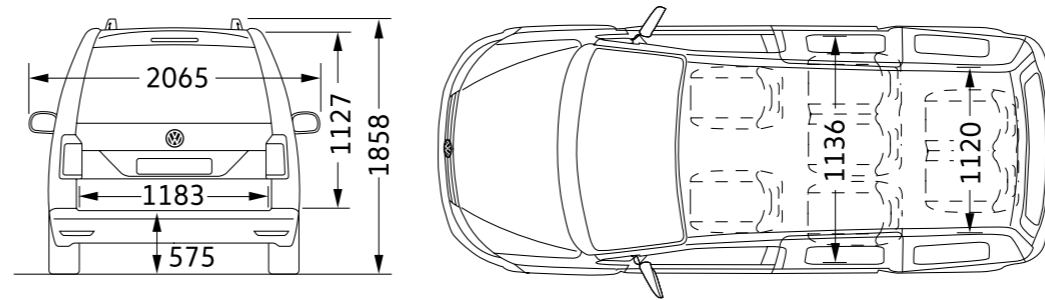
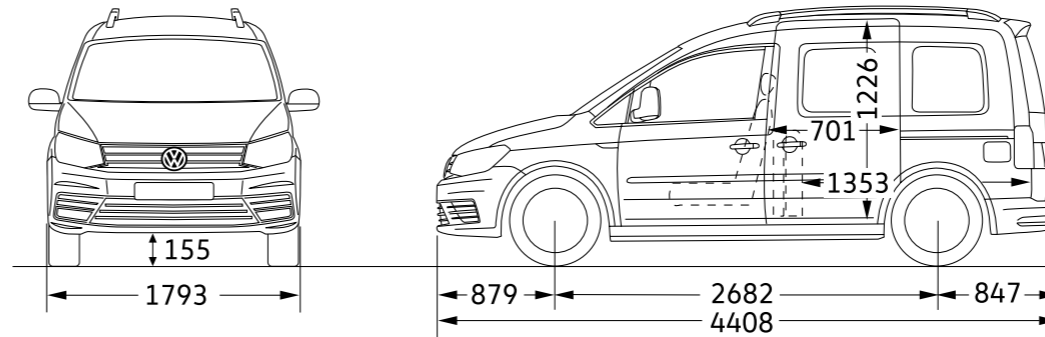

Caddy Maxi Life.

Wheelbase		3,006
Load compartment	length	1,823
	width	1,121
	width between wheel arches	1,120
	height	1,233
	load volume (seats in place)	2 seats: 4,130 litres 5 seats: 1,650 litres 7 seats: 530 litres
load length (seats in place)	2 seats:	2,250
	5 seats:	1,566
	7 seats:	644
Side sliding door	width	701
	height	1,084
Tailgate	width	1,183
	height	1,127
Turning circle (wall to wall)		12.2m

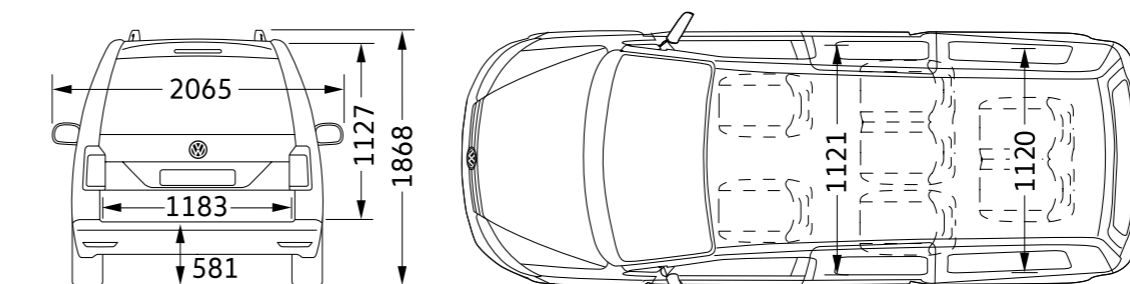
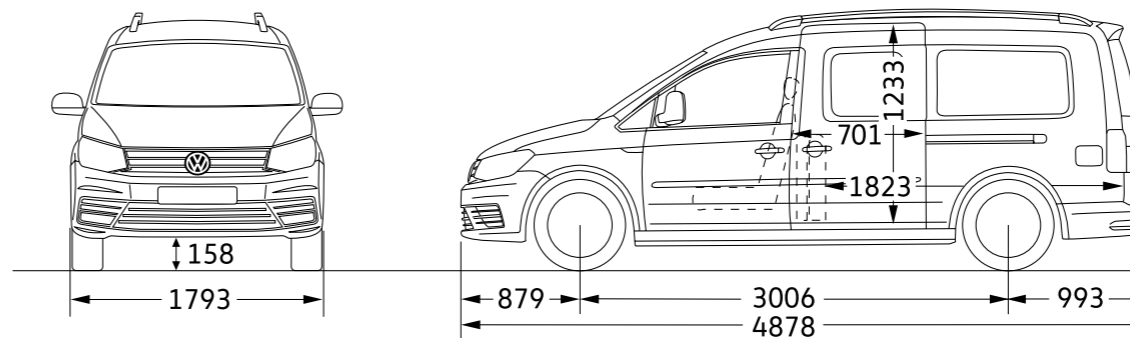

Please note: Vehicle drawings are not to scale. All dimensions in millimetres (mm), unless otherwise stated. The height measurements listed may vary by ± 50mm depending on model and equipment fitted.

Price list.



***Manufacturer's on the road (OTR) package.**

CO ₂ emissions g/km	131-150
Delivery to Van Centre	£595.00
Number plates	£20.00
VAT	£123.00
First registration fee	£55.00
Vehicle excise duty (VED) 1st year	£515.00
Basic OTR price (exc. VAT)	£1,185.00
Total OTR price (inc. VAT)	£1,308.00

Model prices.

Trimline	Engine/transmission	Fuel type	CO ₂ emissions g/km ¹	Basic exc. VAT	Total inc. VAT	Total RRP inc. OTR* exc. VAT	Total RRP inc. OTR* inc. VAT
Caddy Life	2.0TDI 102PS 5-speed manual	Diesel	131	£17,225.00	£20,670.00	£18,410.00	£21,978.00
	2.0TDI 102PS 6-speed DSG	Diesel	142	£18,780.00	£22,536.00	£19,965.00	£23,844.00
Caddy Maxi Life	2.0TDI 102PS 5-speed manual	Diesel	134	£19,555.00	£23,466.00	£20,740.00	£24,774.00
	2.0TDI 102PS 6-speed DSG	Diesel	142	£21,110.00	£25,332.00	£22,295.00	£26,640.00

* Please click here for more details on manufacturer's on the road (OTR) package.

¹ This brochure relates to vehicles tested according to WLTP technical procedures. Figures shown are for comparability purposes; only compare fuel consumption and CO₂ figures with other vehicles tested to the same technical procedures. These figures may not reflect real life driving results, which will depend upon a number of factors including the accessories fitted (post-registration), variations in weather, driving styles and vehicle load. There is a new test used for fuel consumption and CO₂ figures (known as WLTP). The CO₂ figures shown however, are based on a calculation designed to be equivalent to the outgoing (NEDC) test cycle and will be used to calculate vehicle tax on first registration. For more information please visit <https://www.volkswagen-vans.co.uk/en/about-us/wltp.html> or consult your authorised Volkswagen Van Centre. The CO₂ figures are reflective of the standard specification. Adding options, such as different wheels or tyres may affect the final CO₂ figures. For further information please see page 18 to view the full range of CO₂ emissions, or consult your authorised Volkswagen Van Centre.

Data correct at 11.12.2018. Figures quoted are for a range of configurations (including non-UK) and are subject to change due to ongoing approvals/changes.

Options.

	Life.		Maxi Life.	
	Basic exc. VAT	Total RRP inc. VAT	Basic exc. VAT	Total RRP inc. VAT
Paint.				
Solid. Candy White (B4B4), Cherry Red (4B4B).	○	○	○	○
Metallic. Acapulco Blue (2W2W), Bamboo Garden Green (3T3T), Blackberry (COC0), Chestnut Brown (H4H4), Fortana Red (I9I9), Indium Grey (X3X3), Mojave Beige (1B1B), Reflex Silver (8E8E), Sandstorm Yellow (9U9U), Starlight Blue (3S3S), Viper Green (6B6B).	£425.00	£510.00	£425.00	£510.00
Pearl effect. Deep Black (2T2T).	£425.00	£510.00	£425.00	£510.00
Upholstery.				
Seat trim covers in Kutamo fabric.	●	●	●	●
Seat trim covers and armrests in Mesh Leatherette.	£55.00	£66.00	£55.00	£66.00
Interior trim colour.				
Titanium Black/Titanium Black – Titanium Black/Black. Seats in Titanium/Dashboard upper in Titanium Black – lower in Titanium Black/Floor covering in Black.	●	●	●	●
Titanium Black-Blue/Titanium Black – Titanium Black/Titanium Black. Seats in Titanium Black-Blue/Dashboard upper in Titanium Black – lower in Titanium Black/Floor covering in Black.	●	●	●	●
Titanium Black-Moon Rock/Titanium Black – Moon Rock/Titanium. Seats in Titanium Black-Moon Rock/Dashboard upper in Titanium Black – lower in Moon Rock/Floor covering in Black.	●	●	●	●
Seating.				
Deletion of 3rd row of seats. Includes deletion of seat preparation.	-	-	○	○
Heated driver and front passenger seats.	£250.00	£300.00	£250.00	£300.00
Height adjustment for driver and front passenger seats with drawers under front seats.	£125.00	£150.00	£125.00	£150.00
Seats – 3rd row seats deleted.	-	-	○	○

● Standard – Not available ○ At no extra cost Where additional equipment is required by chosen options, additional equipment will be charged at the prices shown.

Options (continued).

	Life.		Maxi Life.	
	Basic exc. VAT	Total RRP inc. VAT	Basic exc. VAT	Total RRP inc. VAT
Wheel and tyres.				
15" Steel wheels with full wheel covers. Weight optimised.	●	●	-	-
16" Bendigo alloy wheels. 6J x 16.	£900.00	£1,080.00	○	○
16" Fortaleza alloy wheels. 6J x 16.	-	-	●	●
17" Canyon alloy wheels, Anthracite. 6J x 17.	-	-	£595.00	£714.00
Wheel and tyre accessories.				
Delete spare wheel.	○	○	○	○
Tyre mobility kit in lieu of spare wheel. Includes 12V compressor and tyre sealant.	○	○	○	○
Audio and communications.				
App-Connect. Only in combination with Discover Media navigation system at an additional cost.	£130.00	£156.00	£130.00	£156.00
Composition Media DAB+ radio system with 6.33" touch-screen.	£265.00	£318.00	£265.00	£318.00
Discover Media navigation system. Includes Guide and Inform, SD card maps.	£720.00	£864.00	£720.00	£864.00
Media control and App-Connect. Only in combination with Discover Media navigation system at an additional cost.	£175.00	£210.00	£175.00	£210.00
Comfort and convenience.				
Sun visor and vanity mirror (with airbag sticker), driver.	●	●	●	●
Sun visor and vanity mirror (with airbag sticker), passenger.	●	●	●	●

● Standard - Not available ○ At no extra cost Where additional equipment is required by chosen options, additional equipment will be charged at the prices shown.

Options (continued).

	Life.		Maxi Life.	
	Basic exc. VAT	Total RRP inc. VAT	Basic exc. VAT	Total RRP inc. VAT
Driver assistance.				
Adaptive Cruise Control (ACC) including speed limiter.	£240.00	£288.00	£240.00	£288.00
Front Assist including City Emergency Braking System with Adaptive Cruise Control (ACC). Only in combination with Adaptive Cruise Control (ACC) including speed limiter (8T7) at an additional cost.	○	○	○	○
High Beam Assist. Only in combination with Discover Media navigation system (Z49).	£125.00	£150.00	£125.00	£150.00
Park Assist. Parallel parking assistant with front and rear parking sensors. Only in combination with Discover Media navigation system (Z49).	£585.00	£702.00	£585.00	£702.00
Park Assist with rear-view camera. Parallel parking assistant with front and rear parking sensors and rear-view camera. Only in combination with Discover Media navigation system (Z49).	£800.00	£960.00	£800.00	£960.00
Parking sensors, rear.	£275.00	£330.00	£275.00	£330.00
Parking sensors, rear with rear-view camera. Only in combination with a tailgate.	£475.00	£570.00	£475.00	£570.00
Power steering with mobility aid.	£70.00	£84.00	£70.00	£84.00
Packages.				
Bi-xenon headlights with tinted tail lights.	£665.00	£798.00	£665.00	£798.00
Body-coloured bumpers, door mirrors and door handles.	●	●	●	●
Electrically foldable, adjustable and heated mirrors.	£125.00	£150.00	£125.00	£150.00
Heating and ventilation.				
Cooled glove compartment.	£115.00	£138.00	£115.00	£138.00
Climatic air conditioning.	●	●	●	●
Climatronic air conditioning.	£475.00	£570.00	£475.00	£570.00
Windows.				
Fixed window on driver side in driver compartment.	-£95.00	-£114.00	-£95.00	-£114.00
Fixed window on passenger side in passenger compartment.	-£95.00	-£114.00	-£95.00	-£114.00
Privacy glass, rear.	£155.00	£186.00	£155.00	£186.00

● Standard – Not available ○ At no extra cost Where additional equipment is required by chosen options, additional equipment will be charged at the prices shown.

Finance made simple.

As dedicated to finance as we are to your new Caddy Life.

Learn more about our range of finance products to find a finance package that suits your budget.

Alternatively, 'Click on' the Offers & Finance button above to find out more about our latest offers to help your business thrive.

Cost of your vehicle

Deposit
As little as one monthly repayment

Monthly repayments
Spread across 18 to 49 months

Optional final payment
You have three choices at the end of your agreement



Own

Hire

Cost of your vehicle

Deposit
As little as one monthly repayment

Repayments
Spread across 12 to 60 months

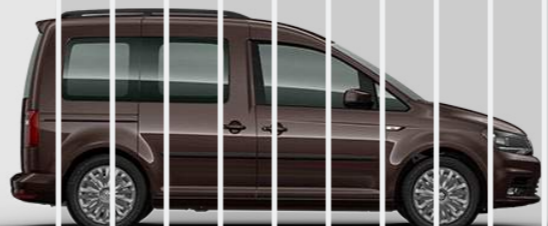

Own

Cost of your vehicle

Deposit
As little as one monthly repayment

Rental repayments
Spread across 12 to 48 months

Final 'balloon' repayment



Own

Solutions Personal Contract Plan

Not sure if you want to own or hire? Make the decision later.

Pay monthly payments for the length of your agreement. At the end you can decide to keep (once all payments have been made), upgrade or return the vehicle.

Hire Purchase

Make all the regular monthly payments. At the end the vehicles is yours.

Lease Purchase

Make lower monthly payments by deferring an amount until the end. Once paid the vehicle is yours.

Cost of your vehicle

Initial rental
As little as one rental repayment

Rental repayments
Spread across 12 to 60 months



Hire

Cost of your vehicle

Initial rental
As little as one rental repayment in advance

Rental repayments
Spread across 12 to 60 months



Hire

Cost of your vehicle

Initial rental
As little as one rental repayment in advance

Rental repayments
Spread across 12 to 48 months

Final 'balloon' repayment
You have two options at the end of your agreement



Hire

Contract Hire

Pay fixed monthly rentals to hire the vehicle. Look after it so at the end you can return it hassle free.

Finance Lease (full pay out)

Pay monthly rentals to hire the vehicle. At the end you have two options. Sell the vehicle and receive a percentage of the sale proceeds. Or retain the use of your vehicle by paying a reduced annual rental.

Finance Lease (balloon repayment)

Pay monthly rentals to hire the vehicle. At the end you have two options. Sell the vehicle to settle the outstanding amount and receive any excess sale proceeds. Or pay the 'balloon' payment and retain the use of your vehicle by paying a reduced annual rental.

Finance subject to status. Available to 18s and over in the UK only. Terms and Conditions apply. Volkswagen Commercial Vehicle Financial Services.

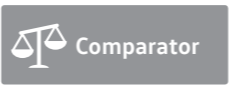
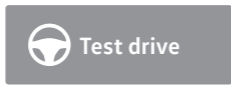

Service & warranties.

Finance and insurance.¹

When it comes to paying for your vehicle, we've got options including Contract Hire and Finance Lease, or Hire Purchase. We can also offer you competitive insurance.

A choice of packages.²

Whether you prefer to lease your vehicles, with none of the concerns of ownership and the freedom to change models easily, or purchase outright to own the vehicle, we're here to help you consider your options.

You can go flexible, by choosing a payment plan that suits your finances, with options to reduce your monthly costs and your repayment period. Or choose a fixed monthly price that allows you to budget confidently for the longer term.

You can even include your road tax and servicing costs to arrive at one simple, all-inclusive payment. For more information, pick up a finance brochure, or ask at your Van Centre.

Volkswagen insurance.

Volkswagen Commercial Vehicles Insurance¹ provides cost-effective and comprehensive motor insurance³, as well as gap insurance⁴, which helps replace your vehicle and protect you from any financial shortfall if it's written off.

Insurance benefits include:

- Complimentary 5-day drive away insurance cover.
- All repairs performed by approved repairers.
- Volkswagen Genuine Parts[®] used on all repairs.
- Courtesy vehicle provided during repair following an accident (subject to availability).
- Cover for breakage and damage to glass.
- In-vehicle personal belongings cover (up to £250).
- Vehicle recovery.
- 90-day European Union cover.

For more information about our motor insurance call: **0345 877 6355** (lines open 9am-6pm Monday-Friday) or visit: insurewithvwcv.co.uk

Servicing and support.

We're here to keep you moving, with our range of three award-winning⁵ servicing and maintenance options, as well as free Roadside Assistance. Some exclusions apply. For more detail, please visit www.volkswagen-vans.co.uk/aftersales.

Pay monthly.

This option is available for vehicles that are less than 12 months old and have covered less than 10,000 miles. It makes budgeting easier by splitting the cost of servicing into fixed monthly payments – whether you want Service only; Service and Maintenance; or Service, Maintenance and Tyres.

Pay upfront.⁶

If you can pay for more than one service upfront, we'll help by reducing your costs. Buy two upfront and you'll receive one interim and one full service at a discounted rate. Buy four and you'll receive two interim and two full services, with your next MOT also included.

Pay on demand.

If you're looking for freedom and flexibility with your servicing, it's good to know we're ready when you are. So with our third option, you can choose to pay for your services as and when you need them, with our National Service Pricing. Ask your Van Centre for an up-to-date pricing guide.

Roadside Assistance.

We understand the need to keep you mobile. That's why all new vans come with three-year, unlimited mileage roadside cover. Should the unexpected happen, one call gets you straight through to a team trained to help you through any breakdown or accident. Supporting you every day will be a team of vehicle technicians, fully-trained by Volkswagen and carrying the latest diagnostic equipment, specialist tools and parts.

Assistance benefits include:

- Assistance at home, by the roadside or place of work.
- Recovery to your preferred location.
- Onward travel, for you and your cargo.
- Cover 24 hours a day, 365 days a year.
- Free cover for three years (on new vehicles).
- Unlimited mileage.
- European cover.
- Option to extend cover beyond three years.

Warranties.

You can count on us long after you purchase your Caddy Life, thanks to its comprehensive three-year, 100,000 mile warranty. While your Caddy Life is under warranty, we'll fix any defect in manufacture or workmanship free of charge, even if you purchase and service the vehicle at different Van Centres. Some exclusions apply and the vehicle must be cared for using the guidance in your owner's manual. For more detail, please visit www.volkswagen-vans.co.uk/aftersales.

Extended warranty.

You can also extend your warranty beyond the three-year, 100,000 mile period, choosing either Comprehensive or Major Component cover, as a one-off or monthly payment. For more detail of cover levels, along with terms and conditions, please visit volkswagencvwarranty.co.uk where you'll also be able to obtain a quote and purchase an extended warranty.

Paint and body warranty.

Your Caddy Life's exterior paintwork is covered against manufacturing defects for a period of three years, while its body sections and panels are covered against rusting through from the inside for 12 years. Some exclusions apply and the vehicle must be cared for using the guidance in your owner's manual.

The Van Centre network.

Our **dedicated Van Centre network** is at the core of everything we do and is always there to help. As a separate brand within the Volkswagen Group, it makes sense to make use of your nearest Van Centre – it's full of experts who understand your vehicle better than anyone else and can help you to get the most out of it.

Over **70 Van Centres** and **24 Authorised Repairers**, means you're only around 45 minutes on average from our door.

1 Volkswagen Commercial Vehicles Insurance and Volkswagen Commercial Vehicle Financial Services are trading names of Volkswagen Financial Services (UK) Limited, Brunswick Court, Yeomans Drive, Blakelands, Milton Keynes MK14 5LR, which is authorised and regulated by the Financial Conduct Authority (FCA). Registered in England and Wales No. 2835230. Volkswagen Financial Services (UK) Limited financial services register number is 311988.

2 An offer of finance depends on certain conditions. Finance subject to status. Available to 18s and over. Terms and conditions apply. Volkswagen Commercial Vehicle Financial Services.

3 Volkswagen Commercial Vehicle Insurance is arranged by U K Insurance Business Solutions Limited and is underwritten by U K Insurance Limited. U K Insurance Business Solutions Limited is authorised and regulated by the Financial Conduct Authority and U K Insurance Limited is authorised by the Prudential Regulation Authority and regulated by the Financial Conduct Authority and the Prudential Regulation Authority. U K Insurance Business Solutions Limited. Registered office: Churchill Court, Westmoreland Road, Bromley, Kent BR1 1DP. Registered in England and Wales No. 05196274. Calls may be recorded.

4 Volkswagen Commercial Vehicle Insurance gap insurance is underwritten by MAPFRE Asistencia Compañía Internacional de Seguros y Reaseguros Sociedad Anonima authorised by Dirección General de Seguros y Fondos de Pensiones and subject to limited regulation by the Financial Conduct Authority and Prudential Regulation Authority, number 203041. Details about the extent of their regulation by the Financial Conduct Authority and Prudential Regulation Authority are available on request. MAPFRE Asistencia Compañía Internacional de Seguros y Reaseguros Sociedad Anonima is incorporated and registered in the Kingdom of Spain and registered as a foreign company in the United Kingdom with company number FC021974, acting through its UK branch with branch number BR008042 and whose principal office is at Alpha House, 5th Floor, 24A Lime Street, London EC3M 7HS. Volkswagen Commercial Vehicle Insurance gap insurance is administered by Abraxas Insurance Administration Services Limited, who is authorised and regulated by the Financial Conduct Authority with FCA number 308702 and who acts on behalf of the Insurer. Abraxas Insurance Administration Services Limited is registered in England and Wales with company number: 02928787 and whose registered office is at One Glass Wharf, Bristol BS2 0SX. Volkswagen Financial Services (UK) Limited is authorised and regulated by the Financial Conduct Authority (FCA). Authorisation details can be checked on the Financial Services register at www.fca.org.uk/firms/systems-reporting/register or call 0800 111 6768. Volkswagen Financial Services (UK) Limited is not part of the same corporate group as MAPFRE Asistencia Compañía Internacional de Seguros y Reaseguros Sociedad Anonima and Abraxas Insurance Administration Service Limited.

5 Business Vans Awards 2014 and 2015: Best Service Package for Van Owners.

6 Class 4 MOT only. This option is available to all new and used vehicles up to four years old or with less than 80,000 miles on the clock. Services must be used consecutively prior to vehicle reaching eight years old.

Design	Interior & infotainment	Seating configurations	Assistance systems	Caddy Life	Caddy Maxi Life	Caddy Life & Maxi Life standard equipment	Paint & upholstery	Wheels, audio & communications	Mobile online services	Technical information	Price list	Offers & finance	Service & warranties
--------	-------------------------	------------------------	--------------------	------------	-----------------	---	--------------------	--------------------------------	------------------------	-----------------------	------------	------------------	----------------------

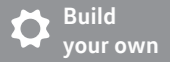

Build
your own



Find a
Van Centre



Test drive



Offers &
Finance



Conversions



Comparator



The Caddy Life

This brochure supersedes all previous publications.

Issue: 7 January 2019

www.volkswagen-vans.co.uk

Please note: Screen technology does not allow exact reproduction of the paint and upholstery colours. Some of the vehicles shown are European specification and may be fitted with optional equipment or accessories that are available at extra cost, or do not reflect current specification. All data and specifications are in accordance with information available at the time of publication and are subject to change without notice. Vehicles not currently in UK stock and customer order vehicles may take a number of weeks for delivery. Certain combinations of vehicle specifications and factory-fitted options are not compatible and therefore all orders received are subject to confirmation. Models, factory fitted-options and paint and upholstery options are subject to availability. Please check details and availability with an authorised Volkswagen Van Centre at the time of ordering.